



Getting Started

Contents	About WordMaker	2
	Overview of WordMaker	4
	Phonics Patterns in WordMaker	4
	Activities	5
	The Activity Screen	5
	Two Types of Lessons	6
	Data Collection	7
	Order of Activities	7
	Activity Flow Chart A — Making Words Lessons I	8
	Activity Flow Chart B — Making Words Lessons II	9
	Activity Flow Chart C — Word Wall Reviews I	10
	Activity Flow Chart D — Word Wall Reviews II	11
	Using Teacher Options	12
	Open Teacher Options	12
	Preferences	13
	Adding Students Names	13
	Changing Preferences	14
	Managing Student Names	14
	Progress Reports and Printouts	15
	Menu Mode	17
	Use Demo Mode to Preview Activities	17
	Switch to Other Programs While in WordMaker	19
	Exit Menu Mode	20

About WordMaker

WordMaker was developed in collaboration with Dr. Patricia M. Cunningham, based on her book "Systematic Sequential Phonics They Use" (Carson-Dellosa).

From the Author

Finding alternative ways to teach children to read for whom learning to read is a struggle has been my lifelong passion. Early in my career, I realized that phonics was a challenge for many children and that getting children to actually use the phonics knowledge they had was an even bigger challenge. Children who could recite the rules about long and short vowels, silent e's etc. rarely used that knowledge when they actually needed it to decode or spell an unfamiliar-in-print word. I began to experiment with a variety of more active "hands-on" ways to teach children to use letter-sound knowledge to decode and spell words.

One of the most successful activities I developed was Making Words. I gave children letters and directed them how to use those letters to spell words. Because the vowel patterns in English are so complex, I paid particular attention to these in our early Making Words lessons. Children were told to use three letters to make the word **bat**. Next I asked them to add just one letter and turn **bat** into **bat**. They used three letters to spell **ran** and then added one letter to spell **rain**. Before long, children had discovered for themselves the "ai" long vowel pattern I had previously tried to teach them. Once this discovery was made, they began effortlessly decoding words with "ai" and using this pattern in their spelling.

The other activity which was particularly successful with struggling readers was showing them how the words they knew could help them read and spell other words. It was astonishing to me how many struggling readers who could read and spell words like **play, rain** and **take** were unable to quickly pronounce less familiar rhyming words such as **spray, brain** and **quake**. I began writing the words a child knew with common rhyming patterns on index cards and displaying these in front of the child. I then showed the child unfamiliar rhyming words and asked the child to find the word with the same pattern and use that word to decode the unfamiliar word. I also said less-familiar words that rhymed and asked the child to find the known rhyming word and use that word to spell the unfamiliar word. Many children made remarkably rapid progress in spelling and decoding when they learned that they could use the rhyming patterns from words they knew to decode and spell hundreds of other words.

WordMaker combines the two activities I have found to be most successful in teaching struggling readers to decode and spell. They manipulate letters to make words, discovering the patterns as they do this. They then sort the words into rhymes and use the rhymes to decode and spell new words. WordMaker is based on years of success with struggling readers of all ages and is grounded in extensive field-testing. Because it is computer-based, students move at their own pace, enjoy individualized lessons and feedback and receive extensive practice on essential decoding and spelling skills.

Thousands of teachers and children have enjoyed making words and learned through these manipulative activities how words work. I hope that children will continue to enjoy and learn from this activity enhanced by the special capabilities of technology.

Pat Cunningham
Professor of Education, Wake Forest University

"... systematic phonics instruction is especially effective. Programs that focus too much on the teaching of letter-sound relations and not enough on putting them to use are unlikely to be very effective. In implementing systematic phonics instruction, educators must keep the end in mind [reading], and ensure that children are able to apply their skills [transfer their knowledge] in daily reading and writing activities."

**U.S. Department of Health and Human Services,
National Reading Panel, 2000**

Overview of WordMaker

WordMaker is the technology version of Dr. Patricia Cunningham's *Systematic Sequential Phonics They Use* book that builds Phonics and Spelling skills for students struggling with decoding and reading.

WordMaker:

- Uses letter manipulation to "make" more than 800 words.
- Includes 140 lessons which correspond directly to lessons in *Systematic Sequential Phonics They Use* by Patricia M. Cunningham (Carson-Dellosa).
- Is designed to teach phonics patterns in a sequence.
- Gives instructions on how to do the lesson, redirects students after errors, and reinforces students during and after activities are completed.
- Models correct pronunciation of letters, sounds and words.
- Lets students see, hear and spell words multiple times to aid in comprehension and retention.
- Presents students with challenge activities at the end of most lessons.
- Has accessibility features built in. Students who have difficulty using a mouse or keyboard can turn on scanning for single switch access to ALL activities. Students who have difficulty using the mouse can use the arrow keys, **Spacebar**, and **Return** (Mac OS) or **Enter** (Windows) to access all activities in the program.

Phonics Patterns in WordMaker

WordMaker is designed to teach the common phonics patterns in the most commonly accepted sequence. The phonics elements are taught in this general order:

Most common consonants	b, c, d, f, g, h, j, k, l, m, n, p, r, s, t, w
Short vowel patterns	a (at), e (end), i (it), o (on), u (up)
Digraphs	ch, sh, th, ck
Long vowel patterns	o (no), e (he), i-e (ride), igh (night), o-e (those), u-e (use), ay (day), ai (rain), ee (see), ea (eat), oa (float)
R-controlled vowels	ar (car), or (for), er (her), ir (girl), ur (hurt)
Other common vowel patterns	oi (oil), oy (boy), aw (saw), au (because), al (walk), ou (cloud), ow (now, slow), oo (zoo, look), ew (new), y (my, very)
Less common consonants/digraphs	v, x, y, z, wh, qu, c (centers), g (gym)
Blends	bl, br, cl, cr, dr, fl, fr, gl, gr, pl, pr, sc, sk, sl, sm, sn, st, sw, tr
Endings (suffixes)	-s, -ed, -ing, -er (person), -er (more), -est (most), -ly

Activities



Integrating Technology

Familiarize yourself with each activity before you present WordMaker to your students! WordMaker's Demo Mode allows you to quickly and easily preview activities at a number of representative Lesson levels. Instructions for using Demo Mode are on page 17 of Getting Started.

There are a number of activities in WordMaker:

Making Words Activities

- Letter/Picture Match
- Spell Words
- Find Words
- Sort by First Letter
- Sort by Rhyme
- Letter/Picture Match (Transfer)
- Spell (Transfer)
- Sort (Transfer)

Challenge Activities

- Secret Word
- Wordo!
- Be a Mind Reader

Each lesson incorporates some of these activities, and centers on developing several types of word skills:

- Manipulating letters to make words Spell Words, Spell (Transfer)
- Sorting words by beginning sound Letter/Picture Match, Letter/Picture Transfer, Sort by First Letter
- Sorting words by ending rhyme Sort by Rhyme, Sort (Transfer)
- Reading/word recognition Find Words, Wordo!, Be a Mind Reader

The Activity Screen

In WordMaker, activities have a consistent interface that makes it easy for students to be successful.

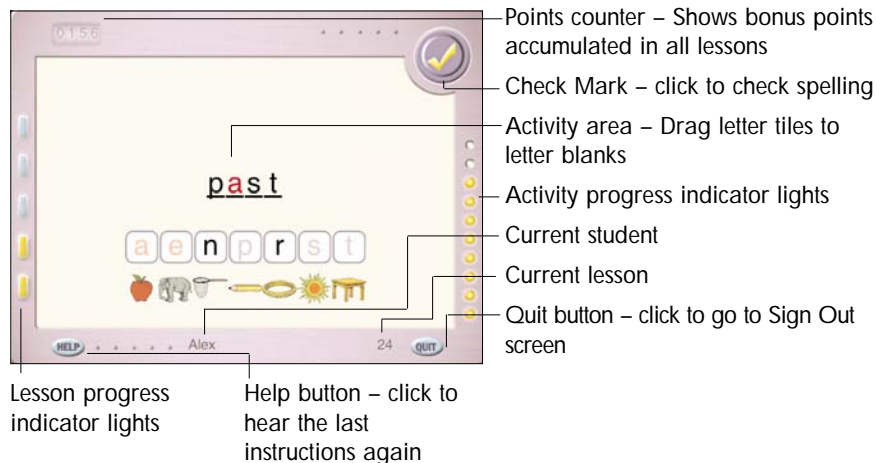

Sample screen from WordMaker (Making Words Lesson 24: Spell Words activity)

Lesson Progress Indicator Light

Elongated indicator lights on the left side of the window correspond to the number of activities for the current lesson. These lights let the student know "where they are" in the lesson. Indicators "light up," changing to bright yellow, as student completes each activity within the lesson. There are 3 to 5 Making Words activities per lesson.



Intervention Strategies

Struggling students who require more tactile reinforcement will benefit from practicing making words using the letter tiles found on page 70 of the Teacher Materials.

Two Types of Lessons



Integrating Technology

When writing or reading text in Write:OutLoud, have students locate their Word Wall words, change the color of those words, and use Write:OutLoud's speech support to hear each word spoken for additional reinforcement.

Activity Progress Indicator Lights

Small, round indicator lights on the right side of the window correspond to the number of steps for the current activity. These lights let the student know how many steps they have completed for the activity. Indicators "light up," changing to bright yellow, as student completes each step within the activity. There are 2 to 12 steps per activity.

Help button

Click this button to repeat the last set of instructions.

Quit button

Click this button to end the lesson and return to the Sign In screen.

Points Counter

Shows points the student has accumulated from the challenge activities (Secret Word, Wordo! and Be a Mind Reader).

Check Mark (in Spell Words, Secret Word and Spell/Transfer activities)

Click this button to check your spelling of the current word.

Current Student

Shows the name of the student who is logged in.

Current Lesson

Shows the number of the lesson which the student is working.

WordMaker contains 140 lessons that teach all the common phonics patterns. The lessons are arranged in 5-lesson sets. The first four lessons in each set are Making Words Lessons. The fifth lesson in each set is a Word Wall Review.

Making Words Lessons

In each Making Words Lesson, students are given a group of letters to make 10-12 words, as well as one "secret word" that uses all the letters from the lesson. Students are given practice spelling and sorting the words in the lesson. Then, students are challenged with a few words using the same beginning letters or the same rhymes to see if they can "transfer" what they learned.

Word Wall Reviews

In each Word Wall Review, students work with some of the words from the previous 4 lessons and add 5 words to their Word Wall. This provides an important review of high-frequency words.

Data Collection



Classroom Implementation

Collect all the data from spelling scores and sorting scores. Use this information as part of your portfolio assessment

WordMaker collects data as students complete activities and lessons. Teachers can view data collected in the student Progress Report, accessed through the Teacher Options screen (see page 16). The student also sees some data in the Lesson Awards screen at the end of each lesson completed.

Type of Score	Data Collected
Spelling score	Composite percentage of words that student spelled correctly in spelling activities during the lesson
Sorting score	Composite percentage of correct sorting by the student during the lesson
Bonus points	Cumulative total of points earned by the student during challenge activities Secret Word, Wordo! and Be a Mind Reader

Note: Student's incorrect spelling attempts, Time on Find activity, and other information can be viewed on the Progress Report, accessed through Teacher Options.

Order of Activities

Making Words Lessons and Word Wall Reviews incorporate different activities to develop and review phonics skills. Also, the sorting activities in Making Words Lessons 1-29 focus on mastery of beginning sounds, while the sorting activities in Lessons 31-139 focus on recognizing patterns in word endings and rhymes. Use the activity flow charts on the next few pages to help understand the order of activities in WordMaker.

Activity Flow Chart A — Making Words Lessons I

(Lessons 1-4, 6-9, 11-14, 16-19, 21-24, 26-29)



Letter/Picture Match

Students must drag each picture to the letter that matches the beginning letter of the word it represents. *Sorting data is tracked.*



Spell Words

Students must drag letters to the letter blanks, then click the Checkmark to see if they are correct. *Spelling data is tracked.*



Secret Word (Challenge)

Students must use all the letters from the lesson to spell a “secret word.”



Sort by First Letter

Students must drag each word to the target letter that corresponds to the first letter of the word. *Sorting data is tracked.*



Letter/Picture Match (Transfer)

Students must drag each picture to the target letter that corresponds to the first letter of the word it represents. (New words) *Sorting data is tracked.*



Wordo! (Challenge)

Students play against the computer in this word bingo game. Click Start Wordo, then click words as they are called.

Bonus points are tracked.

Begins in Lesson 10.

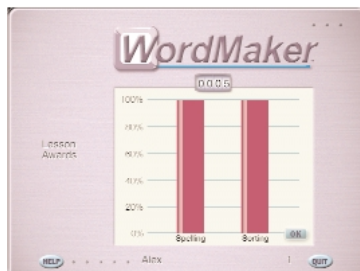

Lesson Award Screen

Students are shown a bar graph with their bonus points, and spelling and sorting scores.

Activity Flow Chart B — Making Words Lessons II

(Lessons 31-34, 36-39, 41-44, etc.)

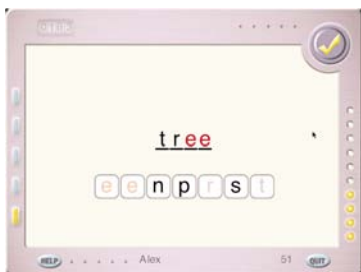

Spell Words

Students must drag letters to the letter blanks, then click the Checkmark to see if they are correct. *Spelling data is tracked.*



Secret Word (Challenge)

Students must use all the letters from the lesson to spell a “secret word.”



Sort by Rhyme

Students must drag each word to the target rhyme that corresponds to the word ending. *Sorting data is tracked.*



Spell (Transfer)

Students must drag letters to the letter blanks, then click the Checkmark to see if they are correct. (New words) *Spelling data is tracked.*



Sort (Transfer)

Students must drag each word to the target rhyme that corresponds to the word ending. (New words) *Sorting data is tracked.*



Wordo! (Challenge)

Students play against the computer in this word bingo game.

OR



Lesson Award Screen

Students are shown a bar graph with their bonus points, and spelling and sorting scores.

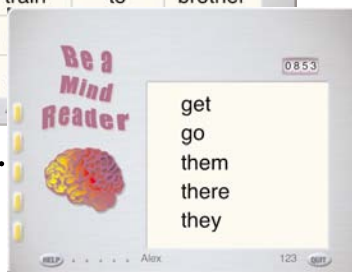

Be a Mind Reader (Challenge)

Students must click to guess a target word based on clues from WordMaker.

Bonus points are tracked.

Activity Flow Chart C — Word Wall Reviews I

(Lessons 5, 10, 15, 20, 25, 30)



Spell Words

Students must drag letters to the letter blanks, then click the Checkmark to see if they are correct.

Spelling data is tracked.



Find Words

Students are shown a word wall with words from the current lesson and must find each word when prompted, before the timer runs out.

Data on length of time needed is tracked.



Sort by First Letter

Students must drag each word to the target letter that corresponds to the first letter of the word.

Sorting data is tracked.



Wordo! (Challenge)

Students play against the computer in this word bingo game.

Bonus points are tracked.

Begins in Lesson 10.

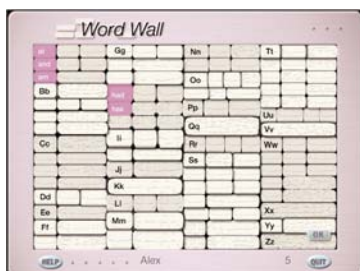

Word Wall

Students are shown the words they have mastered in the 5-lesson unit.



Lesson Award Screen

Students are shown a bar graph with their bonus points, and spelling and sorting scores.

Activity Flow Chart D — Word Wall Reviews II

(Lessons 35, 40, 45, 50, etc.)



Spell Words

Students must drag letters to the letter blanks, then click the Checkmark to see if they are correct.

Spelling data is tracked.



Find Words

Students are shown a word wall with words from the current lesson and must find each word when prompted, before the timer runs out.

Data on length of time needed is tracked.



Wordo! (Challenge)

Students play against the computer in this word bingo game.

Bonus points are tracked.



Word Wall

Students are shown the words they have mastered in the 5-lesson unit.



Lesson Award Screen

Students are shown a bar graph with their bonus points, and spelling and sorting scores.

Using Teacher Options

WordMaker's Teacher Options screen helps you manage student names and view student progress. You can also view and print student Progress Reports, and print Lesson Awards, Worksheets and Word Walls for students to take home.

From Teacher Options, you can:

- Add, edit and/or delete student names
- Change WordMaker preferences to meet student needs
- View and print student progress reports
- Print Lesson Awards, Lesson Worksheets or Word Walls for the current lesson

Open Teacher Options

1. Press **⌘ T** (Mac OS) or **Ctrl T** (Windows) at the Sign In or Sign Out screen.

OR

2. Press **⌘ M** (Mac OS) or **Ctrl M** (Windows) at the Sign In screen or Sign Out screen to show the WordMaker menus.

3. From the File menu, select **Teacher Options...**

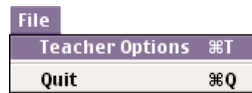

Mac OS menu

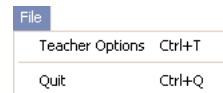

Windows menu

The Teacher Options screen appears.

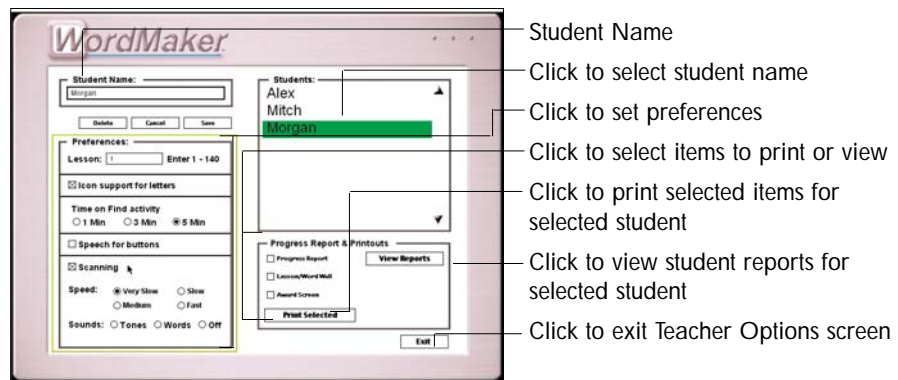

Preferences

Intervention Strategies

If your student is not a switch user but has poor fine motor skills, try using key equivalents to help them navigate through the Activities.

Or

If your student has poor fine motor skills but can press the mouse button, turn scanning on and direct them to use a mouse click to select.

WordMaker includes a number of preferences that can be changed to meet individual student's needs:

Lesson

Shows the WordMaker lesson that the selected student is currently working on. Type a new lesson number (1-140) to move the student to a different lesson.

Icon support for letters

Check ON/OFF icon support for letters in the first 29 lessons. When ON, a picture that begins with the letter appears under the letter tiles for the Spell Words, Sort by First Letter and Letter/Picture/Match (Transfer) activities. If turned OFF, the introductory Letter/Picture Match activity in Making Words Lessons 1-29 will be skipped entirely. The default setting is ON.

Time on Find activity

Choose the amount of time allowed the student — 1, 3, or 5 MINUTES — to complete the Find Words activity in Word Wall Reviews. The default setting is 3 MINUTES. If Scanning is ON, the default setting is 5 MINUTES.

Speech for buttons

Check ON/OFF speech feedback for buttons for students who may need additional speech support for objects and buttons on screen. When ON, buttons and objects will be named when the cursor rolls over them. The default setting is OFF.

Scanning

Check ON/OFF built-in scanning for students who need single-switch input. The built-in scan responds to **1** or a mouse click. The default setting is OFF.

When Scanning is toggled ON, additional preferences become available:

Speed Choose a VERY SLOW, SLOW, MEDIUM or FAST rate for the scanning highlight. This option is only available when Scanning is ON. The default setting is MEDIUM.

Sounds Choose TONES, WORDS or OFF for the student to hear cues while scanning. This option is only available when Scanning is ON. The default setting is TONES.

Adding Students Names



Classroom Implementation

Not enough computers in your classroom to have all your students working on WordMaker at the same time? Have students who aren't working on the computer continue to practice WordMaker phonics skills by participating in one of the Quick Activities that can be found on pages 7-9 of the Teacher Materials.

1. Click in the Student Name field. Student preferences become available.

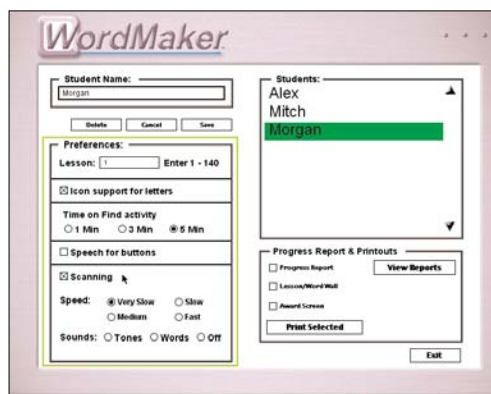

2. Type the student's name.

Note: All names will be listed alphabetically on the Sign In screen.

Changing Preferences

3. Click **Add**, or press **(Return)**, to add the student.
Note: If desired, you may change preferences for the student now, before clicking Add. See "Changing Preferences," below.
 4. Repeat steps 1-3 for each student you want to add.
1. Click the name of the student you want to change preferences for in the Students list.
 2. Click to check or uncheck preferences, or click in the Lesson field and type the desired Lesson number for the selected student..
 3. Click **Save** to save the changes, or click **Cancel** to exit the student's preferences without saving the changes.
 4. Repeat steps 1-3 for each student, as desired.

Managing Student Names

Editing Student Names

1. Click the name of the student you want to edit in the Students list.
2. In the Student Name field, make the desired changes to the name.
3. Click **Save** to save the changes, or click **Cancel** to exit the student's preferences without saving the changes.
4. Repeat steps 1-3 for each student, as desired.

Removing Student Names

WordMaker lists all student names in alphabetical order. To remove student names that are no longer active, delete them from the Students list.

1. Click the name of the student you want to remove in the Students list.
The name will highlight, and all preferences for that student will be enabled.
2. Click **Delete**.
A dialog will appear to confirm the deletion.

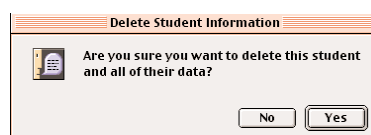

Mac OS dialog

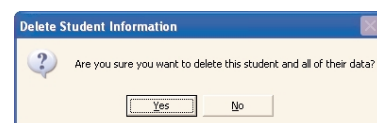

Windows dialog



Classroom Implementation

Sustain motivation!

Give students a checklist with all the lessons listed. Students' self esteem will soar as they check-off each lesson as they successfully complete it.

3. Click **Yes** to delete the name.

The name will be removed from the student list. The student's data will also be cleared.

4. Repeat steps 1-3 for each student name you want to remove.

Progress Reports and Printouts

In WordMaker, teachers can view and print current progress reports, lesson worksheets and awards for individual students from the Teacher Options screen. The Reports/Printouts section is in the lower right section of the screen.

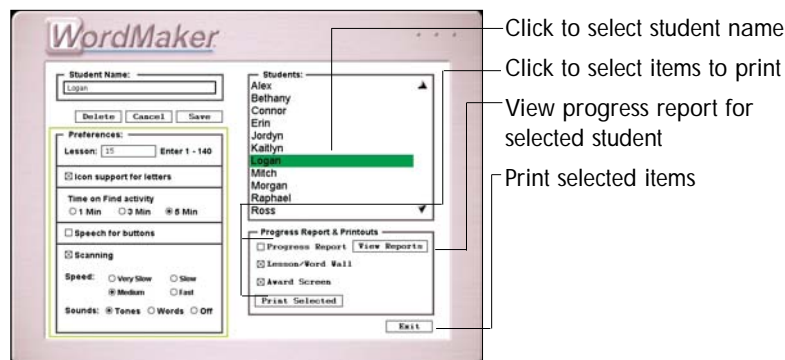

Items that can be selected:

Progress Report A report with student's data for the lessons completed. Includes list of letter sounds in the lessons, word list and incorrect spelling attempts. Can be viewed or printed

Lesson/Word Wall A worksheet for student using study words for Making Words Lesson OR Word Wall for student based on the most current lesson completed.

Award Screen A customized printout for student of percentage correct for WordMaker spelling activities (Spell Words, Transfer Spell), percentage correct for sorting activities (Sort by First Letter, Sort by Rhyme, Transfer Sort) and bonus points awarded to date for Challenge activities (Secret Word, Wordo!, Be a Mind Reader).

Printing from Teacher Options

To print items from the current lesson:

1. Click the name of the student in the Students list.
2. In the Reports/Printouts box, click to check the items you want to print (Progress Report, Lesson/Word Wall, Award Screen) for the selected student.

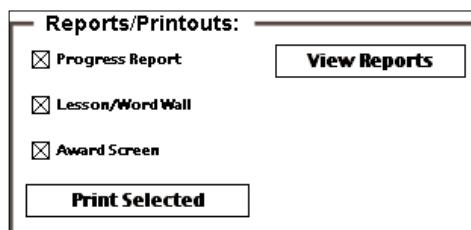

Integrating Technology

Extend reading and spelling skills practice beyond the WordMaker lessons. The Product-Integrated Lesson Plans found on pages 10-24 of the Teacher Materials offer teacher-tested ideas (based on off-computer activities created by Dr. Patricia Cunningham) for using Write:OutLoud, Co:Writer, Draft:Builder, BuildAbility and Start-to-Finish Gold Library books in applying newly-acquired phonics skills beyond the WordMaker lessons



Literacy Instruction

For students who need more reinforcement in applying their WordMaker skills, the Quick Activities (found on page 7-9 of the Teacher Materials) offer fun and effective ways to provide extended, off-computer practice in applying their new word-making skills.

3. Click **Print Selected**.

Depending on your print driver, standard print dialogs may appear to confirm printing options. Respond to these as they appear.

4. The selected items will print.

Note: Word Walls will print after Word Wall Reviews. Lesson Worksheets will print after all other lessons. The Word Wall or Lesson Worksheet will print for the last completed lesson. Lesson Worksheets and Word Walls for ALL lessons are available to view and print in PDF format. Files can be found in the WordMaker Documentation folder on both the computer hard drive (installed in the WordMaker folder) and on the CD-ROM.

Viewing Progress Reports

1. Click the name of the student in the Students list.
2. Click **View Reports**.

The Progress Report screen appears.

3. Use the Select a Lesson popup menu to select the lesson range you want to view.

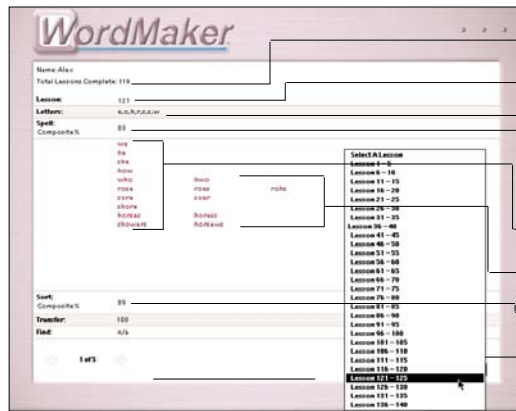

- Total number of lessons completed
- Lesson number
- Letters in lesson
- Composite spelling percentage (# correct/# attempts)
- Words in Spell Words activity
- Incorrect spelling attempts
- Composite sorting percentage (# correct/# attempts)
- Select a Lesson popup menu



Intervention Strategies

Look for error patterns in students' data and have students repeat a spelling or sorting activity for a specific level as repeated practice. Or use a Quick Activity (located on page 7-9 of the Teacher Materials) related to the error patterns you see.

4. If more than one report is available for the selected Lesson Range, click the **Right Arrow** to view the next report. Click the **Left Arrow** to view the previous report.

Note: If a student has repeated a lesson or lessons, data from all lesson attempts is saved and can be reviewed for that student.

5. Click **Print** to print the Progress Report being viewed, if desired.
6. Click **Exit** to return to the Teacher Options screen.

Menu Mode

WordMaker includes a Menu mode that gives teachers easy access to Teacher Options and a Demo mode to preview activities for demonstration or training purposes. Menu mode is available by pressing **⌘M** (Mac OS) or **CtrlM** (Windows) at the Sign In or Sign Out screens.

- Preview activities in Demo mode for training, demonstration, or student placement.
- Set up students and/or view reports in Teacher Options (see "Using Teacher Options," p. 12).
- Switch between WordMaker and other programs on your computer.

Use Demo Mode to Preview Activities

If you are unfamiliar with WordMaker, you may want to preview the activities before setting up student profiles. In Demo mode, there are a limited number of lessons available. These lessons demonstrate the full range of activities in WordMaker. The activities available are from:

- Lesson 11
- Lesson 20
- Lesson 33
- Lesson 80
- Lesson 125

Lessons 11 and 33 are Making Words Lessons; Lessons 20, 80 and 125 are Word Wall Reviews.

Get into Demo Mode

1. Launch WordMaker.
2. At the Sign In or Sign Out screen, press **⌘M** (Mac OS) **CtrlM** (Windows) to display the WordMaker menu bar.

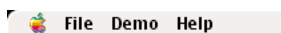

Mac OS menu

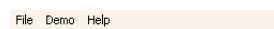

Windows menu

The WordMaker menu remains on screen as a reminder that you are in Menu mode.

3. From the Demo menu, select Demo Mode.



Mac OS menu

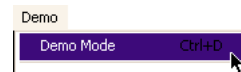

Windows menu

The "Entering Demo Mode" dialog appears.

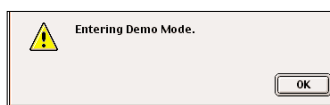

Mac OS dialog

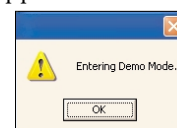

Windows dialog



Integrating Technology

Help students become instantly successful when first using WordMaker. Have students observe as you use Demo Mode to model how each WordMaker activity works BEFORE they sign into the program for the first time, as well as at the key points in the program where activities change (see list of lessons in Demo Mode, page xxx of Getting Started).

4. Click **OK** to continue.

The items in the Demo menu are now available.

Select an Activity

You can select a different activity at any time during the demo.

1. From the **Demo menu**, select the activity you want to try.

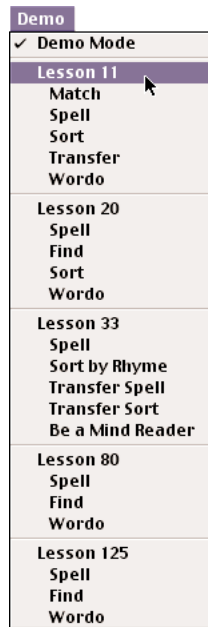

Mac OS menu

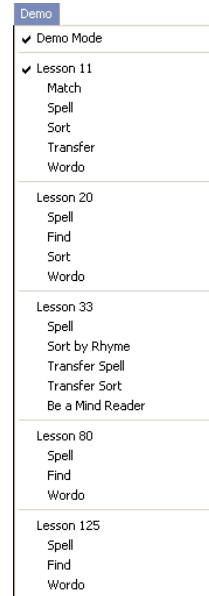

Windows menu

WordMaker switches to the selected activity, and immediately gives the corresponding audio prompts.

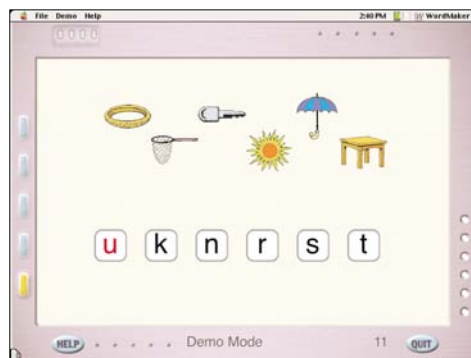

Lesson 11 / Letter Icon Match activity in Demo mode

2. Follow the prompts to try out the activity.

When the selected activity is complete, WordMaker will automatically cycle to the next activity listed in the menu.

You can select a different activity from the Demo menu at any time.

Note: In Demo mode, no student data is saved.

Exit Demo Mode

Exiting Demo mode is similar to entering it.

1. From the **Demo menu**, select **Demo Mode** to uncheck the menu item.



Mac OS menu



Windows menu

A dialog appears to confirm that you are exiting Demo mode.

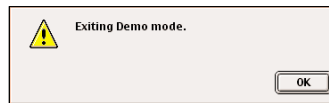

Mac OS dialog

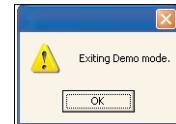

Windows dialog

2. Click **OK** to continue.

Switch to Other Programs While in WordMaker

You can switch to other programs while using WordMaker to view reports or set up students. For example, you might want to track student progress in a spreadsheet or other program. You can do this easily in Menu mode.

Mac OS

1. At the Sign In or Sign Out screen, press **⌘M** to display the WordMaker menu bar
2. Press **⌘T** to open Teacher Options.
3. Click the student name, then click **View Reports** to go to the Report options screen.
4. Select the Lesson range you want to view.
5. Press **⌘Tab** to bring up the Finder menu (or cycle through open applications).
6. At the Finder, you can launch another application.
7. When you are done using the other application, press **⌘Tab** to cycle through open applications until you return to WordMaker.

Windows

1. At the Sign In or Sign Out screen, press **Ctrl** **M** to display the WordMaker menu bar
2. Press **Ctrl** **T** to open Teacher Options.
3. Click the student name, then click View Reports to go to the Report options screen.
4. Select the Lesson range you want to view.
5. Press **Alt** **Tab** to bring up the Windows task bar (or cycle through open applications).
6. From the task bar, you can launch another application.
7. When you are done using the other application, press **Alt** **Tab** to cycle through open applications until you return to WordMaker. Or, click WordMaker on the Windows taskbar.

Exit Menu Mode

Exiting Menu mode is exactly like entering it.

1. Press **⌘** **M** (Mac OS) or **Ctrl** **M** (Windows) to hide the WordMaker menu bar.

The WordMaker menu bar disappears until you enter Menu mode again.

Note: You will also exit Menu mode if you select Quit.